



**WALL-MOUNTED  
MONOBLOCK**

**INSTALLATION, USER  
AND MAINTENANCE  
MANUAL**

**RAV 5038M2Z**

**CE**

**Monoblock**

## INDEX

1.	PRODUCT SPECIFICATIONS .....	2
1.1.	DESCRIPTION .....	2
1.2.	DESIGNATION .....	3
1.3.	OPERATING LIMITS .....	3
1.4.	TECHNICAL CHARACTERISTICS .....	4
1.5.	UNIT DIMENSIONS .....	4
1.6.	EQUIPMENT DESIGN .....	5
2.	UNIT PREPARATION FOR USE .....	5
2.1.	TRANSPORT .....	5
2.2.	IMPORTANT SAFETY WARNINGS .....	6
2.3.	INDICATIONS .....	8
2.4.	INSTALLING THE UNIT .....	10
2.5.	COMPULSORY SPACE TO BE LEFT AROUND THE UNIT .....	11
2.6.	ASSEMBLY .....	11
2.7.	PROTECTIVE DEVICES AND SAFETY MEASURES .....	12
2.8.	CLEANING THE UNIT .....	12
2.9.	DISPOSING OF PACKAGING .....	12
2.10.	CONTROLS, ADJUSTMENTS AND CHECKS TO BE MADE .....	12
3.	OPERATING INSTRUCTIONS .....	13
3.1.	CONNECTING THE UNIT TO EXTERNAL POWER SOURCES .....	13
3.2.	ELECTRICAL POWER CONNECTION .....	13
3.3.	ADJUSTMENT AND CONTROL .....	15
3.4.	COLD ROOM LIGHT .....	15
3.5.	CONTROL DEVICE .....	16
3.6.	CONTROL FUNCTIONS .....	17
3.7.	PARAMETER LIST .....	20
3.8.	INDICATOR LIGHTS .....	21
3.9.	ALARM SIGNALS .....	22
3.10.	COMMON FAILURE ANALYSIS .....	22
3.11.	RESETTING THE ALARMS .....	26
3.12.	EXTERNAL COMMUNICATION .....	26
3.13.	STARTING UP THE UNIT .....	26
3.14.	DIAGRAM OF THE UNIT ELECTRICAL SYSTEM .....	27
4.	MAINTENANCE AND CLEANING .....	29
4.1.	MANUTENCIÓN MAINTENANCE AND REPAIR OF THE UNIT .....	29
4.2.	ORDINARY MAINTENANCE .....	29
4.3.	SPECIAL MAINTENANCE .....	29
4.4.	SERVICING TO BE CARRIED OUT BY QUALIFIED STAFF .....	29
4.5.	TECHNICAL PROBLEMS .....	30
4.6.	OTHER FAILURE ANALYSIS .....	32
4.7.	HOW TO ORDER SPARE PARTS .....	34
4.8.	SCRAPPING THE UNIT .....	34

# 1. PRODUCT SPECIFICATIONS

## 1.1. DESCRIPTION

Wall-mounted monoblock commercial equipments are compact compression cooling units, air-cooled, governed by an intelligent control. The power supply is single phase or three phase depending on the equipment. They consist of:

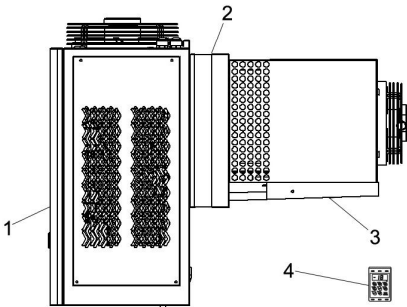

- 1- condenser unit installed externally to the cold room an insulating
- 2- panel for fitting to the wall of the cold room
- 3- an evaporator installed inside the cold room
- 4- an electrical control and command panel, located in the condenser unit
- 5- unit documentation (user and maintenance manual, EC conformity declaration, electrical diagram)

The Wall-mounted monoblock is a totally compact cooling unit, easy to install and with easy access to the inside of the unit, making maintenance simple, quick and safe. It provides a high degree of operating safety as its circuit is totally soldered and ready for mains connection.

- It is constructed in treated sheet metal with a prepainted finish
- Its batteries are built with copper tube and aluminium fins
- The evaporator is forced draught type, with air condensation
- The compressors are hermetic type and run on refrigerant gas R-404-A

The Wall-mounted monoblocks are equipped with:

- Totally integrated remote standard multifunctional electronic control
- Thermostatic expansion valve
- High and low pressure switches.
- Ceramic Filter Drier
- Condensing control
- Automatic defrosting by hot gas
- System for partial evaporation of defrost water
- Interior cold room light and 2.5 m cable
- Cables for supply, door micro switch and cold room light (2,5 m. each)
- Voltage protector
- Probe alert "dirty condenser"

- Insulating buffer
- Refrigerant charge
- Install under roof

And its have the following optional

- Kit for low external temperatures "WinterKit". With this optional the light camera operation from the control board is cancelled.
- Electrical supply at 230/1/60Hz (200-300 series)
- Remote control XWEB

## 1.2. DESIGNATION

<b>RAV – 5038 M – 2-- Z</b>
-----------------------------

<b>RAV</b>	→ Indicates the unit family
<b>5</b>	→ Indicates a group within the family
<b>038</b>	→ Indicates the compressor
<b>M</b>	→ M = refrigeration (medium temperature) L = freezing (low temperature)
<b>2</b>	1 = 230/1/50 → 2 = 220/1/60 3 = 230/3/50 4 = 220/3/60 5 = 400/3/50 6 = 380/3/60 7 = 460/3/60
<b>Z</b>	→ Z = R-404A X= R-449A T= R-452A

## 1.3. OPERATING LIMITS

The Wall-mounted monoblock units are designed for correct continuous functioning between the temperature limits shown in the following table.

	<b>Máx.</b>	<b>Min.</b>
<b>Chiller</b>	+12°C(55°F)	0°C(32°F) *
<b>Freezer</b>	-15°C(5°F)	-25°C(-12°F)

\* The cold room needs to be designed as if it was a freezing chamber.

Sound pressure level dB (A) <70 db (A) at 10 m of the unit measured in open field.

## 1.4. TECHNICAL CHARACTERISTICS

series	Modelo Model Modèle	Pot.Frigorífica Refrig. Capacity Cap. de Réfrig.	Acometida eléctrica Power supply Alimentation	Compresor Compressor Compresseur		R- 404A kg	Intens.Absorb.máx. Max.load current Intensité abs. max.	Peso Weight Poids
		BTU	V – Ph - Hz	CV/HP	kW	kg	A	kg

60 Hz

0°C ~12°C 0°C~0	500	RAV5038M2Z	21,000	220/1/60	3	2.2	<4.0	24.86	195
--------------------	-----	------------	--------	----------	---	-----	------	-------	-----

**The values of the table are approximate, the values on the nameplate are the reals.**

## 1.5. UNIT DIMENSIONS

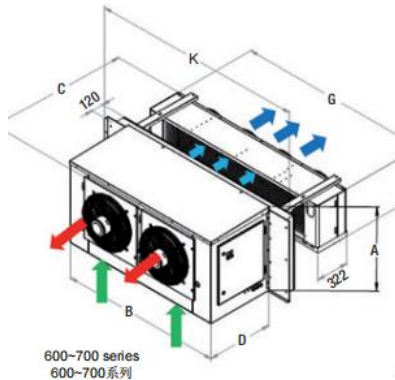

Unit with axial fan (RAV)

series	EQUIPO – UNIT - UNITÉ							CORTE PANEL – PANNEL CUT – COUPÉ PANNEAU	
								TAMPON – PLUG IN – SUR PANNEAU	
	A	B	C	D	F	G	K	HORIZONTAL	VERTICAL
RAV5038M2Z	770	1005	1590	590	635	1095	1275	1145	695

## 1.6. EQUIPMENT DESIGN

The units are agree with the those directives:

- Machine security..... 2006/42/CE
- Electromagnetic compatibility ..... 2004/108/CE
- Low voltage ..... 2006/95/CE
- Pressure units..... 97/23/CE
  - Category art 3.3
  - PS 30 bar

Attached with each unit corresponding EC Declaration of Conformity

## 2. UNIT PREPARATION FOR USE

### 2.1. TRANSPORT

The cooling unit must be handled with care to prevent any damage being caused during transport, in accordance with the following instructions:

- Do not start up the unit until 6 hours have elapsed after transportation
- The unit must be transported and handled in vertical position, protecting it against water and knocks
- Never stack the units during transport
- Never stack more than two units in the warehouse
- Use suitable machinery to move the unit
- Do not remove the pallet or packaging until the machine is in its final location

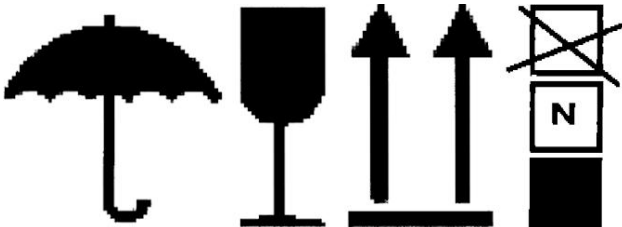

The unit must be moved using suitable means of transport and hoisting, and this must be done by authorised staff. **TO SEPARATE THE UNIT FROM THE PALLET, REMOVE THE FIXING BOLTS.**

## WARNINGS

Ensure no people are transiting through the area in which the machine is being transported and handled. **RISK OF KNOCKS, TRAPPING AND CRUSHING.**

Whether the unit is packaged or not, it must always be transported, hoisted and handled in its original position, never laid down, for safety reasons and to prevent it from falling. **RISK OF BREAKAGE OF THE UNIT, DAMAGE TO THE BUILDING AND PERSONAL ACCIDENT.**



## 2.2. IMPORTANT SAFETY WARNINGS

Below are some safety tips to be followed during the installation and use of the unit.

- The unit must be installed in accordance with the diagrams and recommendations provided by the Manufacturer.
- Damage due to improper connections is not covered.
- A neutral conductor may not be used as a protection conductor, even if it has an earth connection.
- The electrical installation on the premises where the unit is installed must be in compliance with the applicable regulations concerning electrical installations and electromagnetic protection.

- For equipments with centrifugal fan, before starting the machine you must connect a pipe of at least one meter to the fan. This connection must be made so that there are no openings.
- Maintenance of the unit must be carried out by qualified, authorised staff, in compliance with all the stipulations set out in standard EN378 and the regulations applicable to this effect in each particular country.
- Guards should only be removed for maintenance or repair
- It is necessary to consign the before removing the fan guard or remove its guard to perform maintenance or repair

### **WARNING**

To prevent danger of cuts to hands, use protective gloves.

If the user wishes to use the unit for any purpose it is not designed for, particularly during its use, or for any servicing they wish to have done, they must ask the Manufacturer to inform them of any contraindications or hazards that could arise from improper use of the unit.

- The unit must be used in accordance with the instructions for use and for the purposes for which it was designed by the Manufacturer. Any improper use of the equipment constitutes an anomalous condition and may cause damage to the unit itself and be a serious health hazard for other people.

### **CAUTION**

**This unit is not designed to work in an explosive atmosphere. Its use in a potentially explosive environment is therefore strictly forbidden.**

### **CAUTION**

**This unit is not designed to work in a saline atmosphere. In this case the condenser and/or evaporator will need to be protected using the most suitable systems.**

In case of servicing involving the refrigeration circuit, the system must be drained and set at atmospheric pressure



## WARNING

**Cooling fluid must not be discharged into the atmosphere. It must be recycled by authorised specialist technicians with suitable equipment**









- Refrigerant refill is to be carried out in accordance with the indications on the reference plate concerning the type and amount of refrigerant.
- No refrigerant of a type other than that indicated is to be used.
- No modifications or alterations of the components' cooling and electrical circuits are to be made, or any soldering in the compressor or cabling modifications.
- The end user must protect the installation against fire hazard.

### 2.3. INDICATIONS

The manufacturer has applied the use of warning labels and the guidance given in the following summary table.

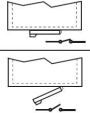
Producto / Product / Produit	RAV5038M2Z000000	
Modelo / Model / Modèle	RAV5038M2Z	
Nº Serie / Serial No. / N° Série	RAV-0001716	
Año Fab. / Man. Year / Année Fab.	2024-12	
Refrigerante / Refrigerant / Réfrigérant	R-404A	
Carga / Load / Charge: (kg)	3.5	
Temperature range:	32~55°F	
Total / Total / Total:	/	
Peso / Weight / Poids (kg)	V / ph. / Hz	I max (A)
195	230/1/60	24.86
According PED 2014/68/UE	PS H/L (bar)	TS (° C)
art4.3	30/17	100/40

- 1) Product
- 2) Unit model
- 3) Unit serial number
- 4) Year of manufacture
- 5) Type of refrigerant
- 6) Amount of refrigerant
- 7) Weight of the unit
- 8) Tension
- 9) Maximum current of the unit
- 10) Category of the equipment
- 11) Maximum design pressure
- 12) Maximum design temperature

	<p><b>Cooling fluid</b></p>
 <p><b>¡Cuidado!</b> Partes calientes/frías Caution! Warm / cold parts ! Attention! Parties chaudes/froides Kontuz! Aide beroak/hotzak</p>	<p><b>Caution: hot or cold parts</b></p>
 <p><b>¡Cuidado!</b> Peligro de electrocución. Caution! Danger of electrocution. ! Attention! Danger d'électrocution Kontuz! Elektrokuzio arriskua</p>	<p><b>Caution: danger of electric shock</b></p>
<p><b>DESAGÜE CONDENSACIÓN</b></p> <p>Condensed drain line</p> <p>Evacuation des condensats</p> <p>Kondentsazioko hustubidea</p> 	<p><b>Condensation drain</b></p>
 <p><b>¡Cuidado!</b> Antes de manipular el equipo quite la corriente. Caution! Switch off before working at the machine. ! Attention! Avant de manipuler coupez le courant Kontuz! Erabili aurretik argi indarra deskonektatu</p>	<p><b>Caution: switch off current before handling the machine</b></p>
<p><b>Cable micro-puerta</b></p> <p>Microswitch door cable</p> <p>Câble micro-porte</p> <p>Ateko mikroaren kablea</p> 	<p><b>Door micro switch cable</b></p>
 <p>L 1 L 2 L 3 Azul - Blue - Urdina N Amarillo-Verde-Yellow-Green-Jane Vert - Horia-Berdia 400 / 3 / 50</p>	<p><b>Colours of supply cable wires</b></p>
 <p><b>400/3/50</b></p> <p>Conectar este cable a un interruptor magnetotérmico. Nunca directamente a la línea principal. Connection should always be made from a fused isolator. Never connect the cable to the main supply line directly. Raccorder ce câble à un interrupteur magnéto-thermique. Jamais directement à la ligne principale. Kable luu etengailu magneto-termitiko batera konektatu. Inoiz ere ez argi indar sare nagaira.</p>	<p><b>Important: Connect this cable to a magnetothermic switch. Never connect it directly to the mains</b></p>
<p><b>Cable luz cámara.</b> No conectar a la línea de alimentación. Coldroom ligh. Do not connect to the supply line. Câble de la lumière. Ne pas brancher à la ligne d'alimentation Kamarako argia. Ez konektatu elikatze sarera</p> <p>230 V / 60 w</p> 	<p><b>Cold room light cable. Do not connect to the supply line. Connect to lamp or porthole.</b></p>

## 2.4. INSTALLING THE UNIT

To guarantee correct functioning of the Wall-mounted monoblock, for optimising its electrical consumption per Kg of product stored and to prevent breakdown, it is vitally important that it is placed in a suitable location and properly used.

### Condenser

- Ensure air is circulating through the condenser
- Locate it away from sources of heat
- Ensure the air entering is as fresh as possible and that the air exiting is not mixed with the air entering
- Ensure there is sufficient space around the air inlets and outlets
- Keep the condenser clean
- Provide an access point for maintenance and servicing
- Provide a drain tube for any condensation that may form.
- The electrical supplies must be protected by suitable magnetothermic switches and differential switches.
- Provide a drain tube for any condensation that may form and connect it to the drain, located in the lower part of the unit

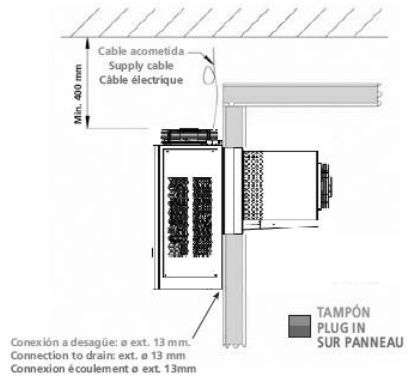

### Evaporator

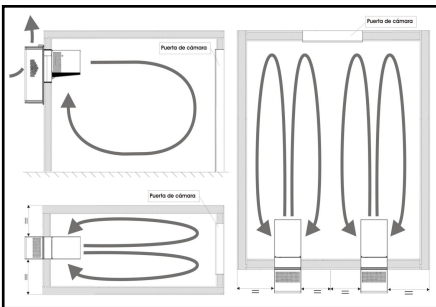

- Make sure the cold room door is only kept open when strictly necessary
- Provide the door with a protective seal to prevent warm, damp air from entering from outside (particularly for low temperature cold rooms and on premises with a high ambient humidity).
- Do not place very hot food inside the cold room (it is not a chiller)
- Do not place food for freezing in the cold room (it is not a cooling tunnel)

- Leave room for the air to circulate. Observe the load limits in the enclosed diagram.
- Seal any points through which air could enter from outside.

**NOTE:** Commercial Wall-mounted monoblock units have a system for partial evaporation of the defrost water. This water must run off to a drain if it does not totally evaporate.

## 2.5. THE UNIT

## COMPULSORY SPACE TO BE LEFT AROUND

The unit's location must allow access for the relevant technical and maintenance service to be carried out, in compliance with all the safety requirements applicable in the country.

## 2.6. ASSEMBLY

- A) Make a hole with the dimensions indicated in the cold room wall.
- B) Place the unit in the cold room, from the outside.
- C) Fix the unit to the wall.
- D) Seal the panel cutting perimeter.

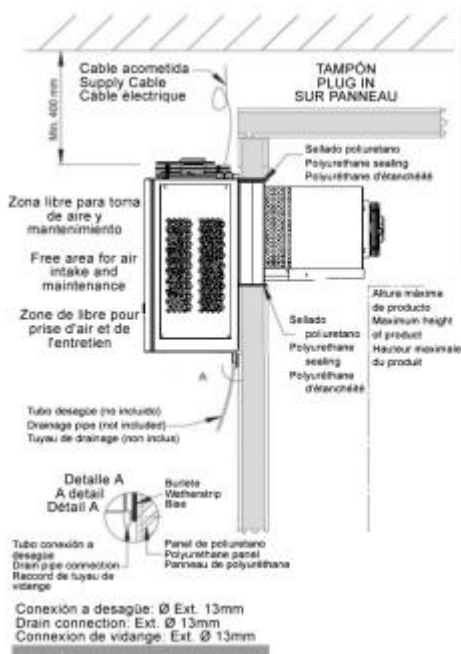

For equipments with centrifugal fan in the condenser, you must install a duct with the following measures for each equipment.

series	Diámetro del conducto
	Duct diameter
	Diamètre conduit
	mm.
RAV5038M2Z	315

## 2.7. PROTECTIVE DEVICES AND SAFETY MEASURES

The manufacturer has provided the following safety protections:

1. The metal casing is bolted to the structure.
2. The fans are bolted to the metal structure.
3. The fan access is covered by a grille bolted in place.
4. The motor compressors have thermal protection.
5. The units have a high pressure switch with automatic reset for protection against high pressures.

### **IMPORTANT**

The protective devices have been fitted by the manufacturer for user safety during work.

## 2.8. CLEANING THE UNIT

Clean the unit with care, removing any dust, foreign bodies or dirt that may have settled on it.

Clean the condenser using a blower every 3 months.

## 2.9. DISPOSING OF PACKAGING

Wooden, cardboard, plastic and polystyrene packaging must be disposed of in accordance with the laws applicable in the country in which the unit is used.

### **CAUTION**

**Do not use solvents**

## 2.10. CONTROLS, ADJUSTMENTS AND CHECKS TO BE MADE

Before starting up the unit, check that:

- the fixing bolts are properly tightened,
- the electrical connections have been properly made.

In case of opening the unit, check that:

- no tools have been left inside the unit
- the assembly has been made correctly,
- there are no gas leaks,
- the front cover has been correctly fitted.

### 3. OPERATING INSTRUCTIONS

#### 3.1. CONNECTING THE UNIT TO EXTERNAL POWER SOURCES

##### **CAUTION**

**Before making the electrical connection, check that the mains voltage and frequency are as indicated on the unit label and that the current remains at a tolerance of +/- 10% with respect to the nominal value. IF THE CURRENT DOES NOT REMAIN WITHIN THIS TOLERANCE, THE USER MUST PROVIDE VOLTAGE STABILISERS.**

#### 3.2. ELECTRICAL POWER CONNECTION

You must perform a preliminary inspection of the components of the electrical panel, and then proceed to the electrical connection.

## CAUTION

The line connection must be made with a suitable protection device (magnetothermic switch or magnetothermic differential switch) selected by the installer or by qualified, authorised staff on the basis of the line type and consumption indicated on the unit label.

If there is more than one unit in a cold room, each unit must have its own protection device.

## CAUTION

The machine must be connected to the grounding system prior to commissioning. The system shall comply with the requirements of national regulations.

## SUPPLY CABLE

230V/1/50-60Hz

3 wires → Blue=Neutral  
Yellow/Green=earth  
Brown, Black or Grey=phase

The unit is equipped with:

- a door micro switch cable (door micro switch not supplied).
- a cold room light cable
- a porthole with an incandescent 230V/60W light bulb.

## CAUTION

Do not connect the door micro switch cables and cold room light cable to the supply line.



### 3.3.

## ADJUSTMENT AND CONTROL

The unit is governed by an electronic circuit board and digital control device.

The unit functioning is adjusted by a cold room thermostatic temperature control according to the temperature setting made by the user. So, when the cold room temperature is higher than the temperature setting plus a differential value, the cooling cycle starts up, and it stops when the cold room temperature is the same as the temperature setting.

In this operating mode the digital display of the control shows the cold room temperature.

The temperature setting can be viewed by pressing the  button, and changed by pressing the  and  buttons.

To protect the compressor from successive start-up and stopping, the adjustment system includes an anti-short cycle timer.

The unit automatically goes into defrost mode after a cooling cycle functioning time of 4 hours. The unit is supplied with the defrost mode controlled by the internal battery temperature. In this mode, the defrosting process ends when the internal battery reaches a temperature of 10°C, or after 25 minutes have elapsed. After defrosting, the unit remains off for the drip time of 3 min so that all the defrost water can run off.

With the configuration the unit is supplied with, the fans remain off during defrosting.

### 3.4.

## COLD ROOM LIGHT

The cold room light is switched off and on directly from the unit control using the  button, providing the porthole is connected to the cold room light cable. With the optional "Winter Kit" the light camera operation from the control board is cancelled.



### 3.5.

## CONTROL DEVICE

This consists of a 3-digit digital display, a keyboard with 6 buttons and lights showing the operating modes, failures and alarms.

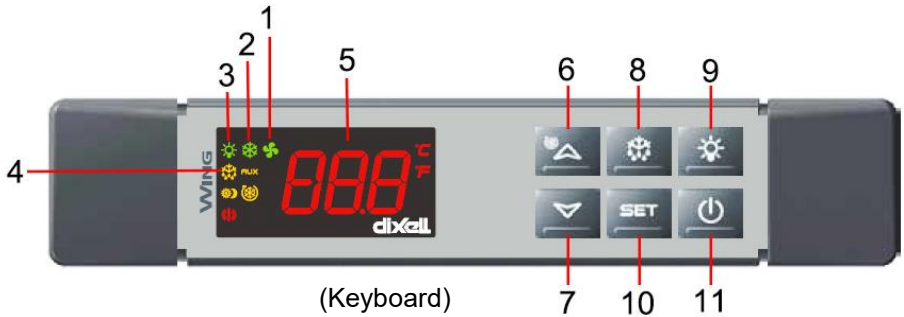

- 1- Evaporator motor fan working light
- 2- Compressor indicator light
- 3- Cold room lamp working light
- 4- Defrost working light
- 5- Display screen
- 6- Increase the value
- 7- Decrease the value
- 8- Defrost button
- 9- Cold room lamp button
- 10- Set the cold room temperature or enter and exit parameter code.
- 11- On / Off the refrigeration unit



For viewing and changing the temperature setting. In programming mode, it enables a parameter to be selected and a value to be confirmed. If it is pressed and held down for 3 seconds, when the max. and min. temperatures set are shown they will be erased.



For viewing the maximum temperature set. In programming mode it enables the parameter list to be browsed or the value displayed to be increased.



For viewing the minimum temperature set. In programming mode it enables the parameter list to be browsed or the value displayed to be reduced.



If this button is pressed and held down for 3 seconds, the defrost cycle begins.



For switching the cold room light on or off.





For switching the refrigeration unit on or off.



### 3.6.

### CONTROL FUNCTIONS

#### Lock and unlock the keyboard.



To avoid un-professional people to operate, we can lock the keyboard.

Lock: Press  and  for 3 seconds, “Pof ” will appear. It means we lock the keyboard.

Unlock: Press  and  for 3 seconds, “Pon” will appear. It means we unlock the keyboard.

#### ① Set the target room temperature

The factory setting of the chiller is 2°C (36°F), the freezer is -18°C (0°F)

Press , it will appear the target room temperature, then press  or  to change it.







#### ② Set the temperature differential

The factory setting of temperature differential is 2°C (4°F)

For example, if the target room temperature is 3°C and the temperature differential is 2°C, then the cold room temperature range will be 3~5°C.

For example, if the target room temperature is 36 °F and the temperature differential is 4 °F, then the cold room temperature range will be 36~40°F.

The step to modify the temperature differential is as below:



Press  and  for 3 seconds, it appears “Hy” (entered the first parameter list). Press  to enter, you will see factory setting of temperature differential is 2°C(4°F). Press  or  to change it. Then press  to exit.



### ③ How to change defrost interval.





The factory setting of defrost interval is 4 hours.

For example, when the first defrost is finished, then 4 hours later, the second defrost will begin.

The code of defrost interval is “IdF”. The step to modify is as below:

Press  and  for 3 seconds, it appears “Hy” (entered the first parameter list).

Then press  and  again for 7 seconds, it appears “Pr2” and then “Hy” (entered the second parameter list).



Press  to find “IdF”, then press  to enter, you will see factory setting of defrost interval is 4 hours. Press  or  to change it. Then press  to exit.



### ④ How to change defrost end temperature.

The factory setting of defrost end temperature is 10°C(50°F).

For example, during defrosting, when the defrost probe sensing the suction tube's temperature rise to 10°C(50°F), then the defrost will be end.

The code of defrost end temperature is “dtE”. The step to modify is as below:

Press  and  for 3 seconds, it appears “Hy” (entered the first parameter list).

Then press  and  again for 7 seconds, it appears “Pr2” and then “Hy” (entered the second parameter list).

Press  to find “dtE”, then press  to enter, you will see factory setting is 10°C(50°F). Press  or  to change it. Then press  to exit.

### ⑤ How to defrost by manual.

The refrigeration unit will defrost automatically. But you can also defrost by manual.

Press  for 3 seconds, when the defrost working light is on, it means the defrost begins.







### ⑥ How to change lower temperature limit.

The factory setting of lower temperature limit is 0°C (32°F) for chiller, -25°C (-12°F) for freezer.



For example, for freezer room, if you want to set the target room temperature to -26°C (-14.8°F), firstly you have to relax the lower temperature limit to -26°C (-14.8°F). Then you can begin to set the target room temperature.

The code of lower temperature limit is “LS”. The step to modify is as below:

Press  and  for 3 seconds, it appears “Hy” (entered the first parameter list).

Then press  and  again for 7 seconds, it appears “Pr2” and then “Hy” (entered the second parameter list).

Press  to find “LS”, then press  to enter, you will see factory setting is 0°C (32°F) for chiller, -25°C (-13°F) for freezer.



Press  to change it lower. Then press  to exit.



### ⑦ How to change upper temperature limit.

The factory setting of upper temperature limit is 10°C (50°F) for chiller, -15°C (5°F) for freezer.



For example, for freezer room, if you want to set the target room temperature to -10°C (14°F), firstly you have to rise the upper temperature limit to -10°C (14°F). Then you can begin to set the target room temperature.

The code of upper temperature limit is “US”. The step to modify is as below:

Press  and  for 3 seconds, it appears “Hy” (entered the first parameter list).

Then press  and  again for 7 seconds, it appears “Pr2” and then “Hy” (entered the second parameter list).

Press  to find “US”, then press  to enter, you will see factory setting is 10°C(50°F) for chiller, -15°C(5°F) for freezer.

Press  to rise it. Then press  to exit.

### 3.7. PARAMETER LIST

Below is the parameter of factory setting. Enter the second parameter list to check.

	Freezer (°C)	Chiller (°C)	Freezer (°F)	Chiller (°F)	
<b>Code</b>	<b>Value</b>	<b>Value</b>	<b>Value</b>	<b>Value</b>	
Set	(-)18°C	2°C	0°F	36°F	Set point
Hy	2°C	2°C	4°F	4°F	Differential for temperature Alarm / fan / defrost
LS	(-)25°C	0°C	(-)13°F	32°F	minimun set point
US	(-)15°C	10°C	5°F	50°F	maximun set point
Ot	0	0	0	0	Room probe calibration (probe 1)
P2P	Y	Y	Y	Y	Probe 2 present
OE	0	0	0	0	Defrost probe calibration (probe 2)
P3P	N	N	N	N	Probe 3 present
O3	0	0	0	0	Display probe calibration (probe 3)
P4P	Y	Y	Y	Y	Probe 4 present
O4	0	0	0	0	Display probe calibration (probe 4)
OdS	1'	1'	1'	1'	Outpufs activation delay at start up
AC	3'	3'	3'	3'	Anti-short cycle delay
Ac1	5'	5'	5'	5'	2nd compressor delay at start up
rTr	100%	100%	100%	100%	Percentage of the second and first probe for regulation
CCt	0	0	0	0	Compressor ON time during fast freezing
CCs	(-)25°C	(-)5°C	(-)13°F	23°F	Set point for continuous cycle
COH	15	15'	15	15'	Compressor ON with faulty probe
COF	30'	30'	30'	30'	Compressor OFF with faulty probe
	<b>DISPLAY</b>	<b>DISPLAY</b>	<b>DISPLAY</b>	<b>DISPLAY</b>	
CF	°C	°C	°F	°F	Temperature measurement unit
rES	de	de	de	de	Resolution (integer/decimal point)
Lod	P1	P1	P1	P1	Local display
rEd	P1	P1	P1	P1	Remote display
dLy	0	0	0	0	Display delay
dtr	50%	50%	50%	50%	Percentage of the second and first probe for visualization
	<b>DEFROST</b>	<b>DEFROST</b>	<b>DEFROST</b>	<b>DEFROST</b>	
tdF	IN	IN	IN	IN	Defrost type
dFP.	P2	P2	P2	P2	Probe section for defrost end
dIE	10°C	10°C	50°F	50°F	Defrost end temperature
IdF	4h	4h	4h	4h	Defrost interval
ndF	25'	25'	25'	25'	(Maximum) length for 1st defrost
dSd	0	0	0	0	Start defrost delay
dFd	It	It	It	It	Display during defrost
dAd	30'	30'	30'	30'	Display delay after defrost
Fdt	3'	3'	3'	3'	Draining time
dPO	n	n	n	n	Defrost at power on
dAF	2'	2'	2'	2'	Defrost delay after fast freezing
	<b>FANS</b>	<b>FANS</b>	<b>FANS</b>	<b>FANS</b>	
FnC	c-n	c-n	c-n	c-n	Fan operating mode
Fnd	3'	3'	3'	3'	Fan delay after defrost
Fct	0	0	0	0	Temperature differential avoiding short cycles of fans
FSt	18°C	18°C	65°F	65°F	Fan stop temperature
Fon	1'	1'	1'	1'	Fan ON time
FoF	15	15	15	15	Fan OFF time
FAP	P2	P2	P2	P2	Probe selection for fan management
	<b>TERMOSTATO</b>	<b>AUXILIAR</b>	<b>TERMOSTATO</b>	<b>AUXILIAR</b>	
AcH	valor por defecto	valor por defecto	valor por defecto	valor por defecto	Kind of action for auxiliary regulator
SAH	valor por defecto	valor por defecto	valor por defecto	valor por defecto	Set point for auxiliary regulator
SHy	valor por defecto	valor por defecto	valor por defecto	valor por defecto	Differential for auxiliary output
APF	valor por defecto	valor por defecto	valor por defecto	valor por defecto	Probe for auxiliary regulator
Sdd	valor por defecto	valor por defecto	valor por defecto	valor por defecto	auxiliary relay off during defrost

	ALARMAS	ALARMAS	ALARMAS	ALARMAS	
ALP	P1	P1	P1	P1	Probe selection for alarm
ALC	abs	abs	abs	abs	Alarms configuration - relative / absolute
ALU	(-)59°C	15°C	23°F	59°F	High temperature alarm
ALL	(-)35°C	(-)5°C	(-)31°F	23°F	Low temperature alarm
AFH	2°C	2°C	4°F	4°F	Differential for temperature Alarm / fan / defrost
ALd	60'	60'	60'	60'	Temperature alarms delay
dAO	1.3h	1.3h	1.3h	1.3h	Temperature alarm delay at power on
AP2	P4	P4	P4	P4	Probe selection for temperature alarm of condenser
AL2	-10°C	-10°C	14°F	14°F	Low temperature alarm of condenser
AU2	53°C	53°C	127°F	127°F	High temperature alarm of condenser
AD2	3°C	3°C	5°F	5°F	Differential for temperature condenser alarm recovery
Ad2	1'	1'	1'	1'	Condenser temperature alarm delay
dA2	0.1	0.1	0.1	0.1	Condenser temperature alarm exclusion at star up
bLL	n	n	n	n	Compressor off with LOW temperature alarm of condenser
AC2	n	n	n	n	Compressor off with HIGH temperature alarm of condenser
	SALIDAS	AUXILIARES	SALIDAS	AUXILIARES	
tbA	Y	Y	Y	Y	Alarm relay reset
oA3	Lig	Lig	Lig	Lig	fourth relay configuration
AoP	Cl	Cl	Cl	Cl	Alarm relay polarity
	ENTRADAS	DIGITALES	ENTRADAS	DIGITALES	
i1P	OP	OP	OP	OP	Digital input polarity
i1F	PAL	PAL	PAL	PAL	Digital input configuration
d1d	20	20	20	20	Digital input 1 alarm delay
i2P	OP	OP	OP	OP	Digital input 2 polarity
i2F	dor	dor	dor	dor	Digital input 2 configuration
d2d	15	15	15	15	Digital input 2 alarm delay
Hps	2	2	2	2	Pressure switch number
odc	F.C	F.C	F.C	F.C	Compressor and fan status when open door
rrd	y	y	y	y	Output restart after doA alarm
HES	0	0	0	0	Temperature increase during the Energy Saving Cycle
	OTROS		OTROS		
PbC	NTC	NTC	NTC	NTC	Type of probe
Adr	1	1	1	1	Serial address
onF	OFF	OFF	OFF	OFF	on/off key enabling
dP1.					Thermostat probe display
dP2.					Evaporator probe display
dP3.					Third probe display
dP4.	0				Fourth probe display
rSE.	4	-15	39	5	Real set point
rEL	1.5	1.5	1.5	1.5	Software release for internal use
Ptb	8	8	8	8	Parameter table code

### 3.8. INDICATOR LIGHTS

Light	Status	Indication
Compressor indicator light	On	The compressor is working.
	Flashing	The compressor stops because of high or low pressure problem, or electric power voltage problem.
Evaporator motor fan indicator light	On	The evaporator motor fan is working.
	Flashing	Programming (flashing together with the compressor indicator light).
Defrost indicator light	On	It is defrosting now.
	Flashing	Defrost complete, water drip time.
Alarm indicator light	On	An alarm is happening
Quick cooling mode indicator light	On	Quick cooling mode activated
Energy saving indicator light	On	Energy saving mode activated
Camera light indicator light	On	Camera light is on
AUX indicator light	On	Auxiliar relay is on

### 3.9.

### ALARM SIGNALS

Message	Cause	Unit action
<b>P1</b>	Cold room temperature probe failure	Flashing P1+ Alarm beep
<b>P2</b>	Defrost temperature probe failure	Flashing P2+ Alarm beep
<b>P3</b>	Condenser probe failure	Flashing P3+ Alarm beep
<b>POF</b>	Locked keyboard	
<b>HA</b>	High temperature alarm (It means now the cold room temperature is too high)	Flashing HA+ Alarm beep
<b>LA</b>	Low temperature alarm (It means now the cold room temperature is too low)	Flashing LA+ Alarm beep
<b>HA2</b>	High condenser temperature alarm (The condenser's temperature now is too high)	Flashing HA2+ Alarm beep
<b>LA2</b>	Low condenser temperature alarm (The condenser's temperature now is too low)	Flashing LA2+ Alarm beep
<b>dA</b>	Door switch alarm	Alarm signal.
<b>CA or PAL or Compressor working light is flashing</b>	High or low pressure alarm. Electric power voltage problem alarm.	Alarm signal. The refrigeration unit stops.

### 3.10.

### COMMON FAILURE ANALYSIS

#### 3.10.1 CA or PAL alarm or compressor indicator is flashing

The keyboard screen show "CA" or "PAL" alarm or compressor working light is flashing.

It means: High pressure or low pressure alarm

High voltage or low voltage alarm

Pls follow the step 1 and step 2 to check the refrigeration unit.

**Step1:**

Check the electric power voltage. The voltage must within the set range. If the voltage is too high or too low, the voltage protector will stop the refrigeration unit. Please open the electric box of this unit, there is a voltage protector inside it(See below photo). If the first light "R/T" is on, it means customer's voltage is ok. If F1 or F2 is on, it means the voltage is too high or too low.



(voltage protector)

If this voltage protector is broken, the refrigeration unit will also stop working. There are two wires below 14 and 11, move out these two wires and let them connect each other directly. Then this refrigeration unit will not be controlled by this voltage protector. Now If the refrigeration unit begin to work again, it means this voltage protector is broken, If the refrigeration unit still can not work, it means this voltage protector is well.

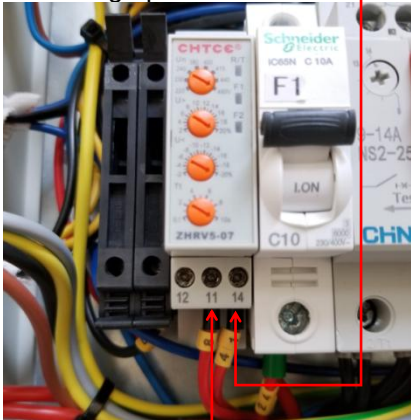



## Step 2:

Use pressure gauge to check the high pressure and low pressure. (see below photo).

- ① If the pressure is too high, maybe because the ambient temperature is too high (make sure there is fresh air around the refrigeration unit), maybe because the condenser motor fan is failure (change the motor fan).
- ② If the pressure is too low, pls check if there is leakage or not, must make sure there is no leakage for this refrigeration unit. Then add some refrigerant. The refrigerant is R404A.
- ③ If the high and low pressure is within standard range, maybe the high pressure switch or low pressure switch is failure. Pls check if the switch is broken or not.

### The standard high pressure and low pressure of the chiller:

In Summer, when the cold room temperature is 0~5 °C (34 °F), the standard low pressure is 3~3.4kg ( about43~49psi ), the high pressure is 17~18kg (about250psi).

In Winter, when the cold room temperature is 0~5 °C (34 °F), the standard low pressure is <3kg (<43psi), the high pressure is 14~15kg (about210psi).

### The standard high pressure and low pressure of the freezer:

In Summer, when the cold room temperature is -18 °C (0 °F), the standard low pressure is 1~1.2kg (about 15psi), the high pressure is 16kg (about230psi).

In Winter, when the cold room temperature is -18 °C (0 °F), the standard low pressure is 0.8~1kg (about 12psi), the high pressure is 15kg (about215psi).

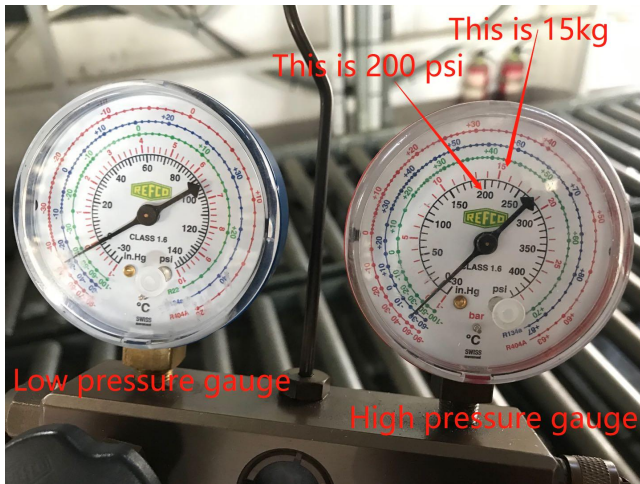

(pressure gauge)



### 3.10.2 DEFROST FAILURE AND EVAPORATOR MOTOR FAN FAILURE



**If the defrost temperature probe was broken, it will bring two problems.**



The first problem: a lot of ice appeared in the evaporator because the refrigeration unit does not defrost automatically.

The second problem: even the compressor working for a long time, the evaporator motor fan still never work.

**Pls check the defrost probe's temperature, its code is "dP2":**

Press  and  for 3 seconds, it appears "Hy" (entered the first parameter list).

Then press  and  again for 7 seconds, it appears "Pr2" and then "Hy" (entered the second parameter list).

Press  or  to find the defrost probe code "dP2" and then press  to see

its value (If you can not find "dP2", pls go to find "prd", then press  you will see "dP2"), If "dP2" temperature is more or less same as the suction copper tube's temperature or same as the cold room temperature, it means the defrost probe is Ok. If "dP2" show the temperature is 40°C or 60°C or 75°C or 100°C, it means the defrost probe must be broken. Pls change to use a new the defrost probe. The probe model is NTC 10K.

About the defrost:

The code of defrost end temperature is "dtE". The factory setting is 10°C (50°F).

The defrost is not only controlled by time, but also be controlled by defrost temperature probe. When the defrost probe temperature is always lower than 10°C, the refrigeration unit can defrost. When the defrost probe temperature is higher than 10°C, it will end defrost or will not defrost.

Defrost probe temperature < 10°C (50°F), can defrost.

Defrost probe temperature > 10°C (50°F), will end defrost or will not defrost.

**So if the defrost probe is broken, the refrigeration unit will never defrost.**

About the evaporator motor fan:

The code of evaporator motor fan stop temperature is "Fst". The factory setting is 18°C (65°F).

The evaporator motor fan is controlled by the defrost probe. When defrost probe temperature is lower than 16°C (61°F), the evaporator motor fan will work. When defrost probe temperature is higher than 16°C (61°F), the evaporator motor fan will stop. (If room temperature differential is 2°C, then 18-2=16°C. If room temperature differential is 4°F, then 65-4=61°F)

Defrost probe temperature  $< 16^{\circ}\text{C}$  ( $61^{\circ}\text{F}$ ), evaporator motor fan will work.  
Defrost probe temperature  $> 16^{\circ}\text{C}$  ( $61^{\circ}\text{F}$ ), evaporator motor fan will stop.  
**So if the defrost probe is broken, the evaporator motor fan will not work.**

### **3.11. RESETTING THE ALARMS**

The alarm signals are silenced by pressing any button or when the cause of the alarm is rectified (according to the option entered for parameter “tBA”, the alarm relay can remain active after the alarm has been silenced).

The sensor failure alarms “P1”, “P2” and “P3” switch off 10 seconds after the failure has been rectified.

The cold chamber temperature alarms “HA” and “LA” switch off when the normal values are reached again or when defrosting begins.

The door alarm “dA” switches off when the door is closed.

In the same way, the external alarms “EAL” and “BaL” switch off when the external digital input is cut off and the alarm “PAL” switches off when the unit is turned off.

### **3.12. EXTERNAL COMMUNICATION**

If you install the optional “remote management”, each unit must be connected via the connector TTL and a converter to a Modbus-RTU network compatible with the monitoring system XWEB.

### **3.13. STARTING UP THE UNIT**

Before starting up the cooling unit, the following operations must be performed:

- Plug the unit into the mains. The display will switch on and the word OFF will appear.
- If warm-up of the unit is required, it must remain in this state for at least three hours.
- If the unit has a voltage monitor incorporated, it must remain turned to OFF for at least 7 minutes, so that the monitor can run the calculation phase.
- Adjust the cold room temperature.
- Start up the unit by pressing the ON/OFF button.

## CAUTION

**Average temperature adjustment field: +12 -0°C**  
**Low temperature adjustment field: -15 -25°C**

Programming the cold room temperature:

- Plug the unit into the mains. The word OFF will appear on the display.
- To configure the desired work program, press the SET button and hold it down for three seconds. The green pilot light will come on and the set value will appear on the display.
- If you wish to change this value, press:

UP to increase it (never any higher than US).

DOWN to reduce it (never any lower than LS).

Press the SET button or wait for five seconds to view the cold room temperature again.

## CAUTION

**24 hours after start-up, check the evaporator conditions. If ice has formed on it, you will need to reduce the defrosting interval. For low temperature units, this inspection must be repeated once a week during the first month of use.**

### 3.14. **DIAGRAM OF THE UNIT ELECTRICAL SYSTEM**

Wall-mounted monoblock commercial units are characterised by a specific electrical installation, a diagram of which is enclosed with this user and maintenance manual.

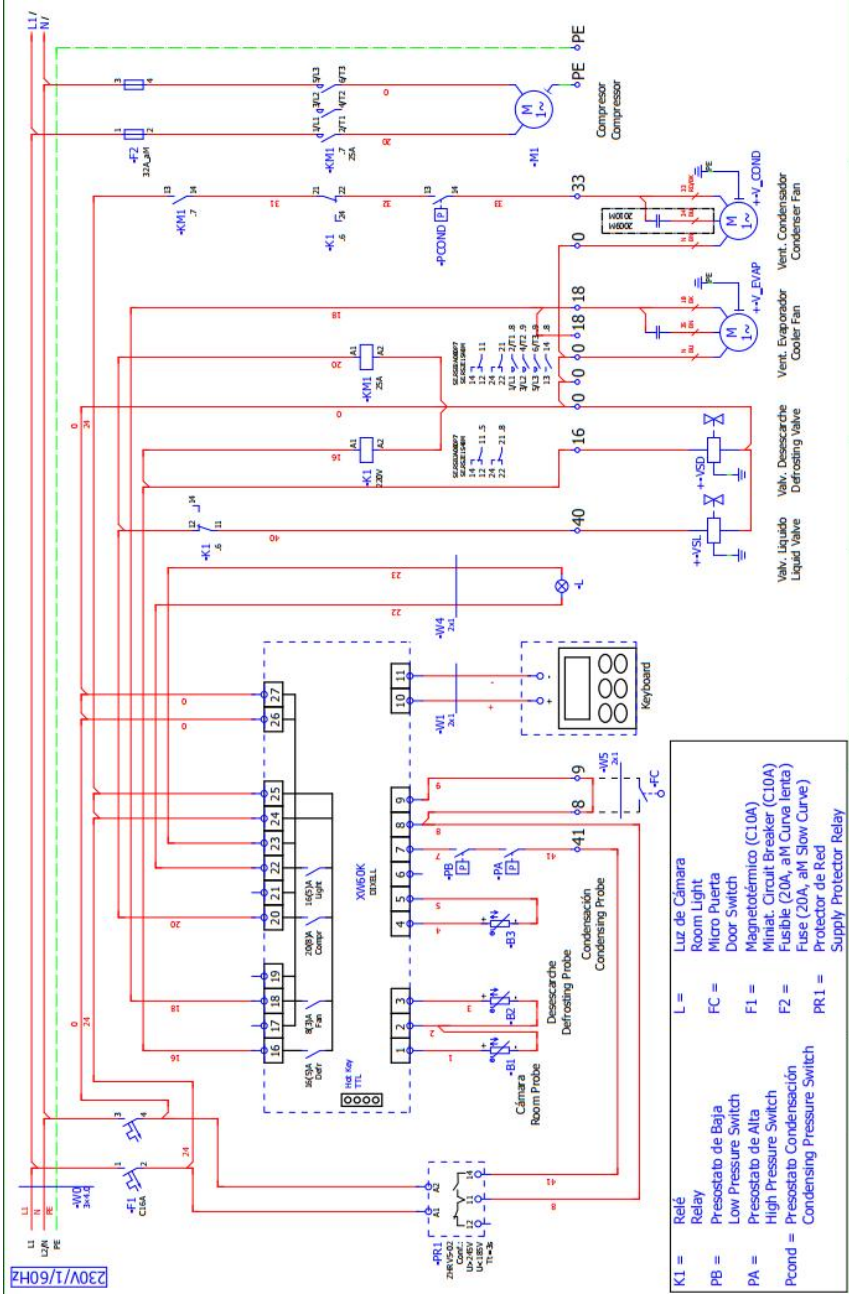

## **4. MAINTENANCE AND CLEANING**

### **4.1. MANUTENCIÓN MAINTENANCE AND REPAIR OF THE UNIT**

Suitable maintenance is a determining factor for the unit to remain in optimum operating and performance conditions throughout a longer lifetime, and to guarantee the safety conditions established by the manufacturer.

### **4.2. ORDINARY MAINTENANCE**

To ensure the unit's correct functioning at all times, the condenser must be periodically cleaned (the frequency of this cleaning will mainly depend on the environment in which the unit is installed).

The unit must be switched off before this operation is carried out: it is advisable to use an air blast from the outside towards the inside. If this is not possible, use a long-bristled brush, brushing from the outside of the condenser.

#### **WARNING**

To prevent risk of cuts to hands, use protective gloves.

#### **WARNING**

Switch off the electrical current before handling the unit.

### **4.3. SPECIAL MAINTENANCE**

Periodically check the state of wear of the electrical contacts and the contactors, and replace them if necessary.

Check the condenser is clean.

Check the cabling is properly fixed in place.

### **4.4. SERVICING TO BE CARRIED OUT BY QUALIFIED STAFF**

There follows a list of maintenance operations requiring specific technical skills and which must therefore be carried out by authorised, qualified staff.

The user must NOT carry out the following operations under any circumstances:

- replacement of electrical components
- manipulation of the electrical system
- repairs to mechanical parts
- manipulation of the refrigeration system
- manipulation of the control panel or the On, Stop or Emergency switches
- manipulation of the protective and safety device systems
- cleaning the condenser

#### **4.5. TECHNICAL PROBLEMS**

The following problems may occur during unit functioning:

1. Wall-mounted monoblocked compressor. There is a protective device which starts up whenever the maximum permitted temperature for the coils of the compressor's electric motor is exceeded.

This may happen if:

- The space the unit is located in is not sufficiently ventilated.
- There are anomalies in the electrical supply network.
- The condenser fan is not functioning properly.
- This protective devices goes back to its original position automatically.

2. Ice formation in the evaporator (preventing correct air flow).

This can be caused by:

- The door being opened too far, or being left open for too long.
- Incorrect functioning of the evaporator fan.
- Solenoid valve failure.
- Incorrect functioning of the defrost system.
- The unit being used for purposes other than those it was designed for, such as freezing products.

In such cases, certain operations can be carried out, always by qualified, authorised staff, unless the unit has been used for freezing:

- Increase the end of defrost thermostat temperature by a few degrees
- Increase the number of defrosts.

### **CAUTION**

**For defrost operations carried out as a result of ice blocking the evaporator, we advise against the use of metal tools, sharp or cutting tools, or hot water.**

3. If the control unit display does not switch on, check:
  - That the unit is connected
  - That the supply cable connection is correct
  - The fuses on the electrical panel.
  
4. If the display switches on but the unit does not start up when the ON/OFF button is pressed, check the door micro switch connection is functioning correctly: remember that with the contact closed the door should be closed (if I1P=OP).

**Poor performance of the unit:**

In case of poor performance, after attempting to find the technical causes no anomaly is discovered in the system, check that the cold room doors are closing hermetically, that there is no cold dispersion in the cold room, that the staff is using the room with due care and that no unfrozen provisions or liquids have been stored in the room when it is used at a low temperature, and whether there is liquid in the evaporator.

It is also advisable to install the unit away from any doors, particularly if these are opened frequently each day.

**WARNING**

During functioning of the unit, it is strictly prohibited to remove the user protection devices fitted by the manufacturer.



## 4.6.

## OTHER FAILURE ANALYSIS

Symptom	Cause	Solution
Very high evaporator pressure with respect to air input.	a) Excess load b) High cold room temperature c) Compressor air intake not correctly sealed	a) Collect refrigerant b) Check for overheating c) Check the state of the compressor and replace it
Very low condensation pressure	a) Insufficient gas b) Low cold room temperature c) Compressor air intake not hermetic d) Liquid circuit Wall-mounted monoblocked e) Solenoid valve totally or partially open	a) Locate leaks and complete the charge b) Wait for start-up c) Check the state of the compressor and replace it d) Check the dehydrator filter and the capillary tube or expansion valve e) Check the valve is not obstructed. Replace it if necessary
Very high condensation pressure (high pressure switch cuts out, "PAL or CA" alarm)	a) Insufficient flow or air recirculation b) Very high cold room temperature c) Condenser is dirty d) Excessive refrigerant charge (condenser flooded) e) Condenser fan has failed f) Air in cooling circuit	a) Check air circuits (flow, recirculation, air outlet obstructed) b) Check temperature setting c) Clean it d) Collect refrigerant e) Repair it f) Drain and charge it
Evaporation pressure too low (high pressure switch cuts out, "PAL" message)	a) Insufficient flow in evaporator. Air recirculation b) Evaporator frozen c) The liquid line is at a different temperature than the filter input and output d) Insufficient gas e) Very low condensation pressure f) Evaporator fan has failed	a) Check the air or water circuits (flow, clean battery, etc.) b) Check the defrost system c) Change the filter d) Locate the leak, complete the charge e) Air temperature in the condenser is very low (very high air flow), adjust flow or relocate unit f) Repair it
Compressor will not start up, it does not sound (buzz)	a) Insufficient supply b) The contacts of one of the control elements are open c) Anti-short cycle timer preventing start-up d) Contact open e) Contactor coil burnt out f) Internal Klixon open	a) Check differential switch and fuses b) Check safety chain on electronic regulation c) Check electronic regulation d) Replace it e) Replace it f) Wait for reset, check absorbed power

Compressor will not start up, motor sounding intermittently	a)Very low network voltage b)Supply cable disconnected	a)Check line voltage and locate voltage drop b)Check the connections
Repeated stoppage and start-up of compressor	a)Due to high pressure b)Regulation differential too low c)Insufficient gas, cut-out due to low pressure d)Evaporator dirty or frosted up e)Evaporator fan not working, low pressure switch cutting out f)Capillary tube or expansion valve damaged or obstructed by impurities (low pressure switch cutting out) g)Dehydrating filter obstructed (low pressure switch cutting out)	a)Check charge b)Increase short cycle difference c)Locate leak, recharge unit d)Clean it, check evaporator air circuit e)Repair or replace it f)Replace it, together with the filter g)Replace it
Compressor is making a strange noise	a)Fixing loose b)Insufficient oil c)Compressor defect	a)Fix it b)Add oil up to recommended level c)Replace it
Noisy functioning	a)Unit installed without anti-vibration supports	a)Install anti-vibration supports
Defrosting is not being performed	a)Electrical fault b)Defrost module not operative c)Solenoid has failed d)Regulation failure	a)Locate and repair it b)Check parameters c)Replace it if necessary d)Locate and repair it

#### 4.7. HOW TO ORDER SPARE PARTS

If you need to order any spares, please state the serial number figuring on the unit label.

#### **WARNING**

Components must only be replaced by authorised, qualified staff.

#### 4.8. SCRAPPING THE UNIT

If the unit is to be scrapped, its components must not be abandoned in the environment; they must be disposed of through companies authorised to collect and recycle special waste, in accordance with the laws applicable in the country in which the unit is used.

#### **WARNING**

Cooling liquid must not be discharged into the atmosphere. It must be recovered and disposed of by companies authorised to collect special waste.

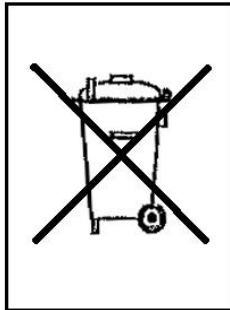

Sello del distribuidor :  
Dealer stamp  
Distributeur seal :

